

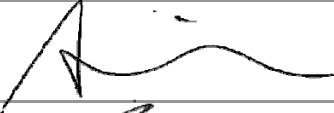

Product/Process Change Notification







PCN#	Effective Date	Issue Date
2013-11-14C-01	From D/C 144	2013/11/14
PCN Classification	Product Category	
Minor	Low vf schottky SMA Package	
Subject		
Tapping Reel Size Revised		
Affected Product(s)		
Product list as attachment		
Description of Change(s)		
In order to improve Production efficiency for product		
Content of Change(s)		
Tapping Leader Size 7 inch (Quantity:1K) to 13 inch (Quantity:5K)		
Impact(s)		
N/A		
Attachment(s)		
Package Information. Specification		

Approval		
Issue by	Alice Lai	e-mail: alice@secosgmbh.com
Development Engineer		Alice Lai
QA Manager		Peter Yang
General Manger		Mathew Liu

For more information, please contact us directly or visit our website <http://www.secosgmbh.com>

Affected Product List

SK12L	SK14L	SK22L	SK24L	SK26LL
SK12LL	SK14LL	SK22LL	SK24LL	SK34LL
SK12SL	SK14SL	SK22AL	SK24AL	
SK12AL	SK14AL			
SK12ALL	SK14ALL			

Exterior comparison Chart	
Original Tapping Reel	Modified Tapping Reel
	
	
	

DO-214AC (SMA)

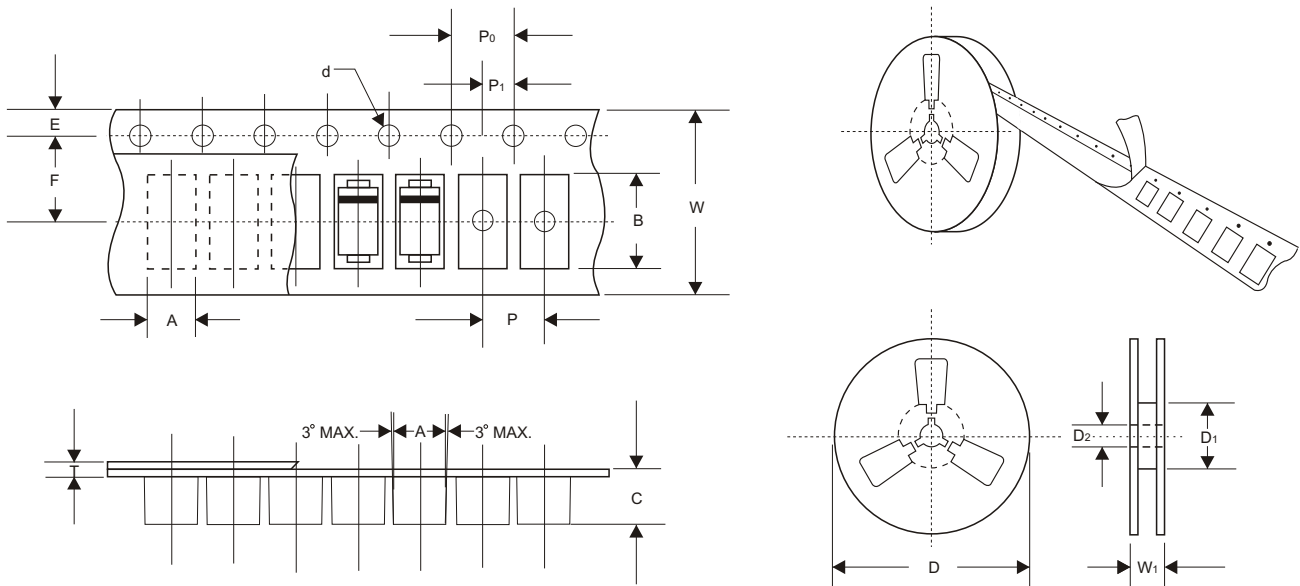

Item	Symbol	Specifications (mm)	Specifications (inch)
Carrier Width	A	2.70 (Max)	0.106 (Max)
Carrier Length	B	5.30 (Max)	0.209 (Max)
Carrier Depth	C	2.66 (Max)	0.105 (Max)
Reel Outside Diameter	D	330 ± 2	12.99 ± 0.787
Sprocket Hole	d	1.50 ± 0.1	0.059 ± 0.004
Reel Inner Diameter	D1	50 (Min)	1.970 (Min)
Feed Hole Diameter	D2	13.5 ± 1.0	0.532 ± 0.004
Sprocket Hole Position	E	1.75 ± 0.10	0.688 ± 0.004
Punch Hole Position	F	5.50 ± 0.05	0.217 ± 0.0019
Punch Hole Pitch	P	4.0 ± 0.10	0.157 ± 0.004
Sprocket Hole Pitch	P0	4.0 ± 0.10	0.157 ± 0.004
Embossment Center	P1	2.0 ± 0.05	0.787 ± 0.0019
Over All Tape Thickness	T	0.60 (Max)	0.011 ± 0.0039
Tape Width	w	12.0 ± 0.30	0.472 ± 0.0079
Reel Width	W1	18.4 (Max)	7.244 (Max)

Reel	Reel Size	Box	Box Size (mm)	Carton	Carton Size (mm)	G.W. (kg)
5,000 pcs	13 inch	10,000 pcs	340 x 340 x 40	80,000 pcs	370 x 360 x 360	12.1